

bdipro®

for
ColdFire



User Manual

Manual Version 1.02 for BDI1000



© 1993-2004 ABATRON AG

1 Introduction	3
1.1 BDI1000.....	3
1.2 Functions	4
2 Installation	5
2.1 Connecting the BDI1000 to Target.....	5
2.1.1 Changing Target Processor Type	7
2.2 Connecting the BDI1000 to Power Supply.....	8
2.2.1 External Power Supply	8
2.2.2 Power Supply from Target System	9
2.3 Status LED «MODE»	10
2.4 Connecting the BDI1000 to Host	11
2.4.1 Serial line communication	11
2.4.2 Ethernet communication	12
2.5 Installation of the bdiPro Software	13
2.6 Configuration	14
2.6.1 BDI1000 Setup/Update	15
3 Specifications	17
4 Environmental notice	18
5 Declaration of Conformity (CE).....	18
6 Warranty	19
 Appendices	
A Troubleshooting	20
B Maintenance	21
C Trademarks	23

1 Introduction

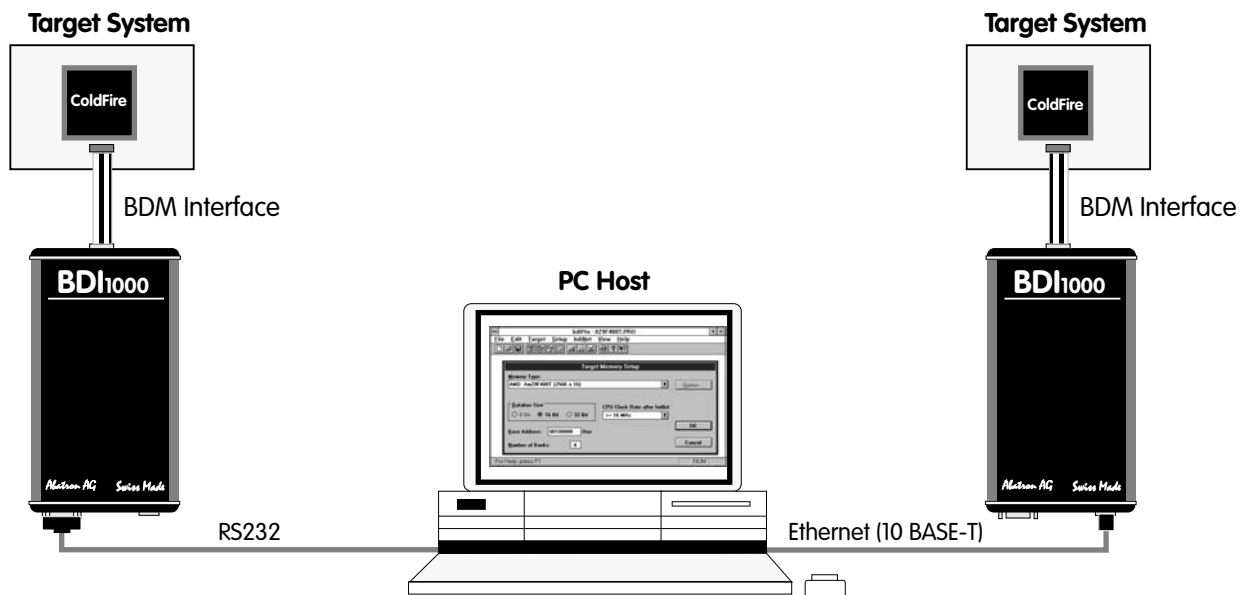

bdiPro is a powerful software package, allowing on-board programming with the BDI1000 from Abatron. bdiPro eliminates the inefficient, individual chip programming, particularly for surface-mounted designs. The unprogrammed memories can be soldered to the printed circuit board and programmed simultaneously on a just-in-time basis.

1.1 BDI1000

The BDI1000 is a processor system in a small box. It implements the interface between the BDM pins of the target CPU and a 10Base-T Ethernet / RS232 connector. BDI1000 is powered by a MC68331, 256Kbyte RAM and a flash memory of 512Kbyte. As a result of consistent implementation of lasted technology, the BDI1000 is optimally prepared for further enhancements. The firmware and the programmable logic of the BDI1000 can be updated by the user with a simple Windows based configuration program. The BDI1000 supports target system voltages from 2.7 up to 5 Volts.

1.2 Functions

The bdiPro software provides the following functions:

File	<i>Load/Save</i>	• Save and recall user defined program sets
	<i>Print</i>	• Print the active program set
	<i>Print Preview</i>	• Display the active program set on the screen
	<i>Print Setup</i>	• Select the printer and the printer connection
	<i>Print Comment</i>	• Edit the headers and comment
Edit	<i>Load</i>	• Load Motorola S-Record and Intel hex program files
	<i>Store</i>	• Store the local memory image in S-Record format
	<i>Dump</i>	• Load the target system data into local memory
	<i>Edit</i>	• Edit the local memory image
	<i>Clear</i>	• Clear the local memory image
	<i>Fill</i>	• Fill a local memory area with pattern
	<i>Checksum</i>	• Calculation of checksum
Target	<i>Erase</i>	• Erase the target memory (all / sectors)
	<i>Program</i>	• Program the target memory
	<i>Verify</i>	• Compare the target system memory with local memory
Setup	<i>Communication</i>	• Communication setup between the PC and the BDI
	<i>Firmware</i>	• Load and verify the firmware
	<i>Target Memory</i>	• Target memory setup (memory type and memory organisation)
	<i>Target Initlists</i>	• User configurable program sequences for target system initialization (clock, chip select...) • If required, you can write special routines that runs before or after the program/erase process (pre-programming, post-programming / pre-erase, post-erase).
Help		• Information about menus and dialog boxes by pressing the F1 function key

2 Installation

2.1 Connecting the BDI1000 to Target

The enclosed cable to the target system is designed for the Motorola recommended 26-pin Berg connector. In case where the target system has an appropriate connector, the cable can be directly connected. The pin assignment is in accordance with the Motorola specification.



In order to ensure reliable operation of the BDI (EMC, runtimes, etc.) the target cable length must not exceed 20 cm (8").

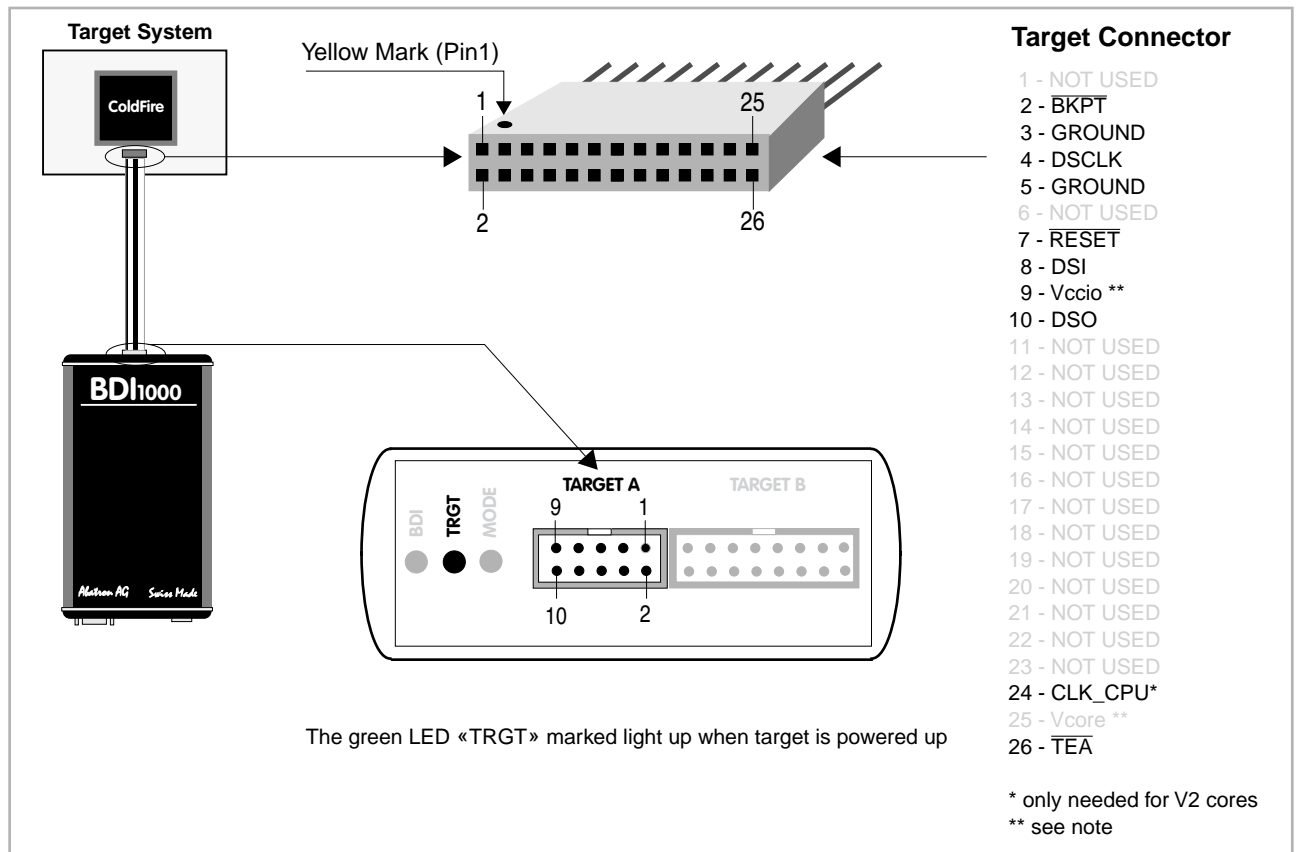

The target CPU clock is only needed for older V2 cores (MCF5204, MCF5206(e) and MCF5272) because DSCLK and DSI have to change synchronous with the CPU clock. For all other cores, BDM communication can be asynchronous to the CPU clock and therefore this signal is not needed.



Important note for older target cables:

The target cables delivered before October 2004 expect the target BDM reference voltage (Vccio) at pin 25 of the BDM connector. For target boards where Vccio is only routed to pin 9, remove the contact/wire from housing pin 25 and insert it into pin 9.

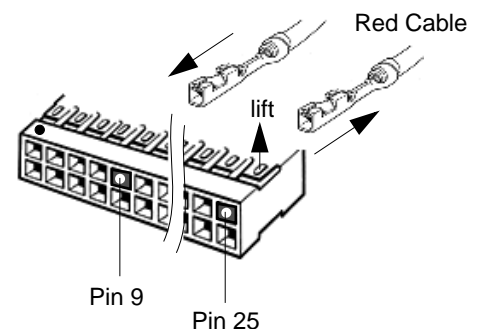

BDI MAIN / TARGET A Connector Signals:

Pin	Name	Description
1	CLK_CPU	PROCESSOR CLOCK For V2 cores, this clock signal is used to synchronize the BDM signals DSCLK and DSI.
2	$\overline{\text{BKPT}}$	BREAKPOINT BKPT is an active-low signal that signals a hardware breakpoint for the ColdFire core. It is used to force the ColdFire core to enter debug mode.
3+5	GROUND	SYSTEM GROUND
4	DSCLK	DEVELOPMENT SERIAL CLOCK For background debug mode, serial shift clock to the MCU.
6	$\overline{\text{TEA}}$ (optional)	TRANSFER ERROR ACKNOWLEDGE (currently not implemented) Active-low open-drain signal, used to abort a bus cycle. This signal may be helpful for ColdFire devices which has no built-in bus monitor (e.g. MCF5307). The BDI is able to terminate an invalid memory access. Otherwise BDM communication may hang until a reset is applied.
7	$\overline{\text{RESET}}$	RESET Active-low open-drain signal, used to force a system reset.
8	DSI	DATA SERIAL IN For background debug mode, serial data input signal to the MCU.
9	Vcc Target	TARGET POWER This input to the BDI1000 is used to detect if the target is powered up.
10	DSO	DATA SERIAL OUT For background debug mode, serial data output from the MCU.

Pin 1 is only use for some older V2 cores (MCF5204, MCF5206(e) and MCF5272). For all other cores this signal is not used.

Custom designs with ColdFire cores:

In order to use Abatron BDM interfaces, it is not necessary to use the space consuming 26-pin Berg connector. If a 10-pin connector is used with the above signals, a simple 10-wire flat cable can be used. Also the CPU pins normally used for PST0..PST3 and DDATA0...DDATA3 can be assigned the alternate function (e.g. parallel port pin in a MCF5206 design).

For more information about the PSTx and DDATAx signals, see the appropriate ColdFire user's manual.

2.1.1 Changing Target Processor Type

Before you can use the BDI1000 with an other target processor type (e.g. ColdFire <--> PPC), a new setup has to be done (see chapter 2.6 «Configuration»). During this process the target cable must be disconnected from the target system. The BDI1000 needs to be supplied **between 2.5V and 5V** via the POWER connector. For more information see chapter 2.2.1 «External Power Supply».



To avoid data line conflicts, the BDI1000 must be disconnected from the target system while programming the logic for an other target CPU.

2.2 Connecting the BDI1000 to Power Supply

2.2.1 External Power Supply

The BDI1000 needs to be supplied **between 2.5V and 5V** via the POWER connector. The available power supply from Abatron (option) or the enclosed power cable can be directly connected. In order to ensure reliable operation of the BDI1000, keep the power supply cable as short as possible.



For error-free operation, the power supply to the BDI1000 must be between 2.5V and 5V DC. **The maximal tolerable supply voltage is 5.25 VDC. Any higher voltage or a wrong polarity might destroy the electronics.**

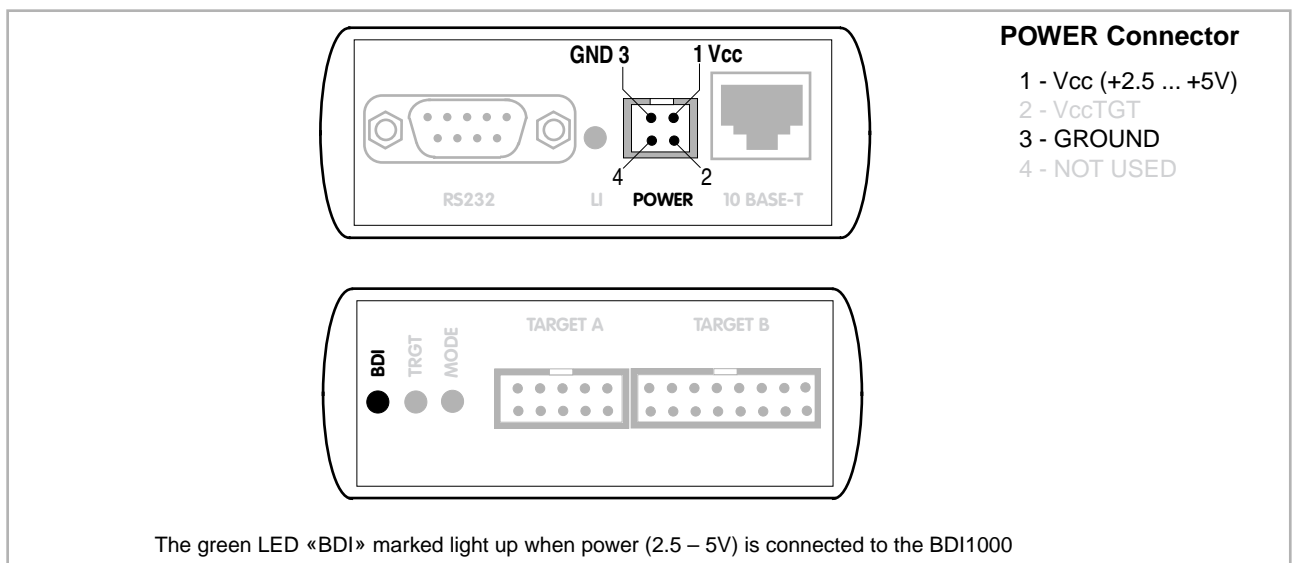

Please switch on the system in the following sequence:

- 1 --> external power supply
- 2 --> target system

2.2.2 Power Supply from Target System

The BDI1000 needs to be supplied between 2.5V and 5V via TARGET A connector. This mode can only be used when the target system runs **between 2.5V and 5V** and the pin «Vcc Target» is able to deliver a current up to:

- 900mA@2.5Vcc Target
- 700mA@3.3Vcc Target
- 450mA@5.0Vcc Target

For pin description and layout see chapter 2.1 «Connecting the BDI1000 to Target». Insert the enclosed Jumper as shown in figure below. **Please ensure that the jumper is inserted correctly.**



For error-free operation, the power supply to the BDI1000 must be between 2.5V and 5V DC. **The maximal tolerable supply voltage is 5.25 VDC. Any higher voltage or a wrong polarity might destroy the electronics.**

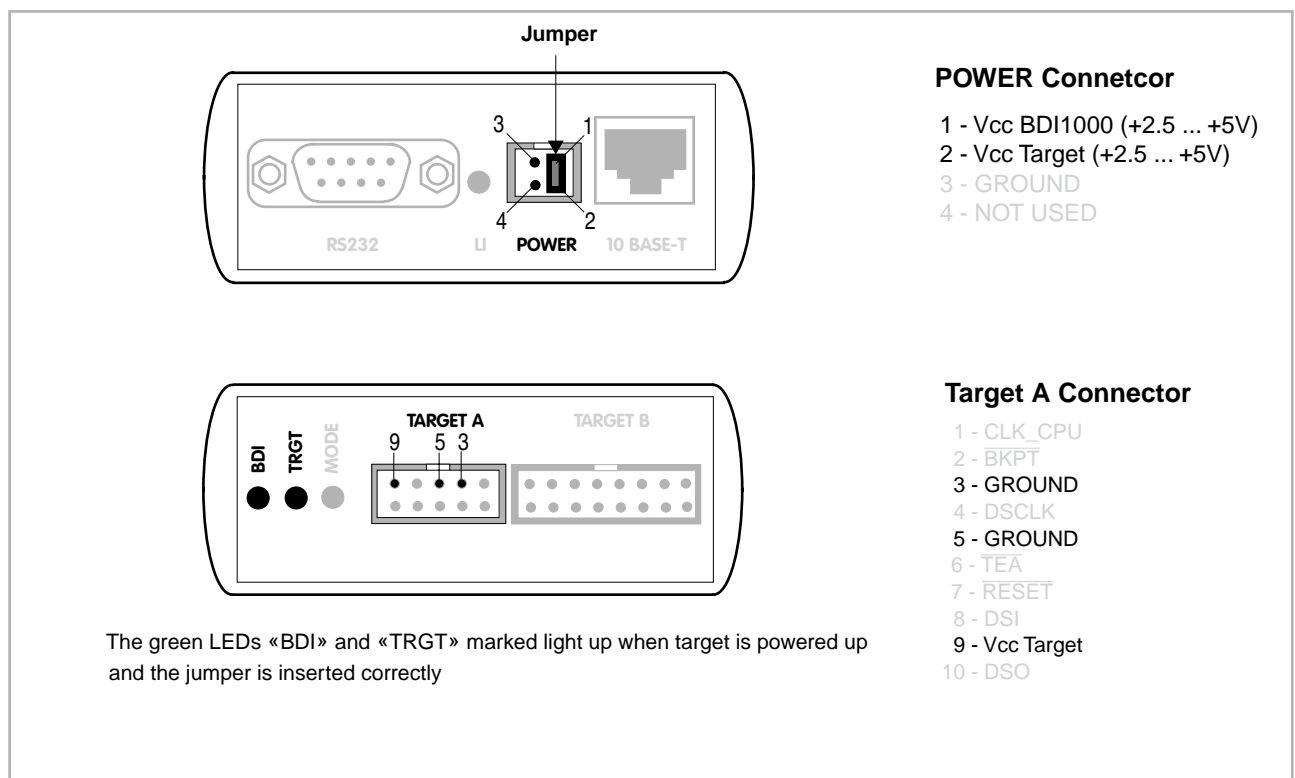

2.3 Status LED «MODE»

The built in LED indicates the following BDI states:

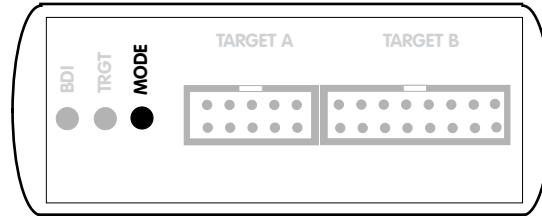

MODE LED	BDI STATES
OFF	The BDI is ready for use, the firmware is already loaded.
ON	The power supply for the BDI1000 is < 2.5VDC.
BLINK	The BDI «loader mode» is active (an invalid firmware is loaded or loading firmware is active).

2.4 Connecting the BDI1000 to Host

2.4.1 Serial line communication

The host is connected to the BDI through the serial interface (COM1...COM4). The communication cable between BDI and Host is a serial cable (RXD / TXD are crossed). There is the same connector pinout for the BDI and for the Host side (Refer to Figure below).

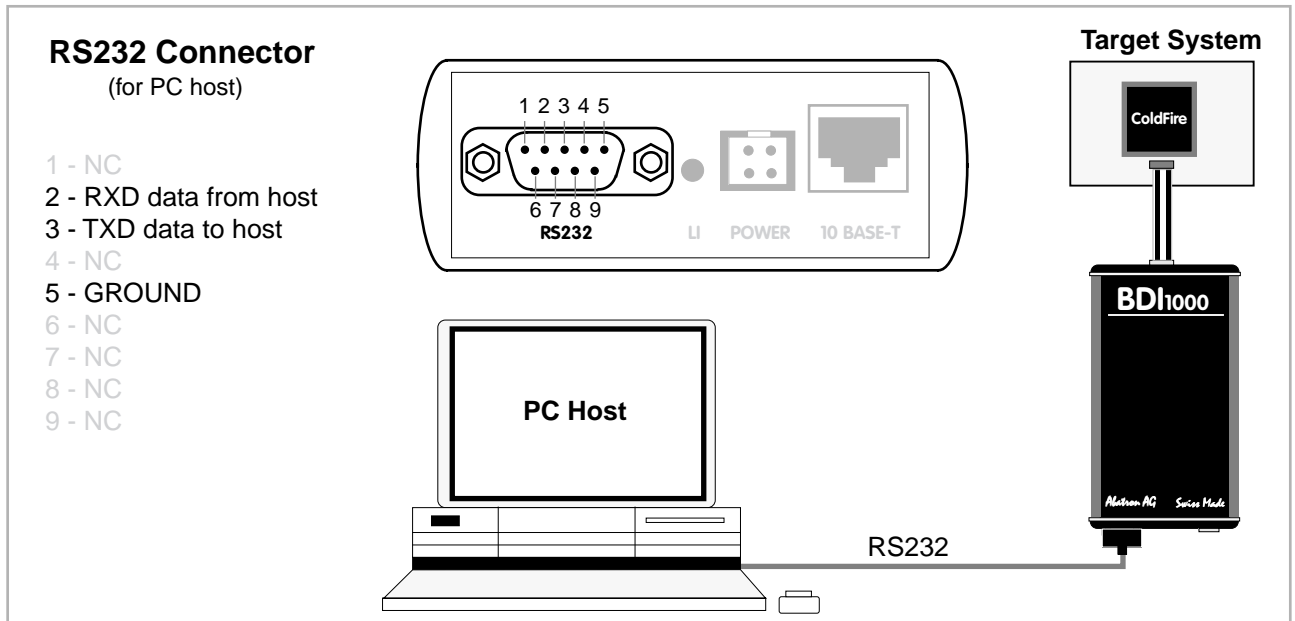

2.4.2 Ethernet communication

The BDI1000 has a built-in 10 BASE-T Ethernet interface (see figure below). Connect an UTP (Unshielded Twisted Pair) cable to the BD1000. For thin Ethernet coaxial networks you can connect a commercially available media converter (BNC --> 10 BASE-T) between your network and the BDI1000. Contact your network administrator if you have questions about the network.

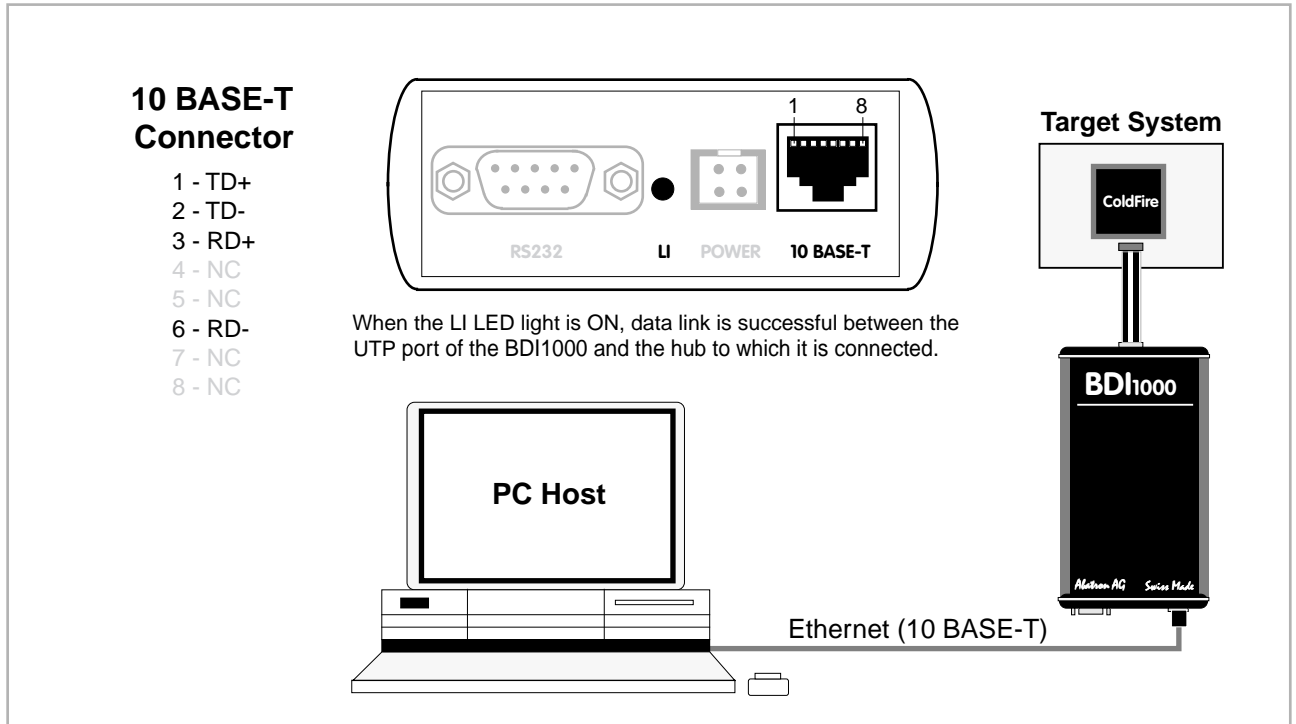

2.5 Installation of the bdiPro Software

On the enclosed diskette you will find the bdiPro software and the firmware required for the BDI. Copy all the files of the desired diskette to a directory on your hard disk.

The following files are on the diskette:

b10pgmcf.exe	bdiPro program
b10pgmcf.hlp	Helpfile for bdiPro program
b10pgmcf.cnt	Help contents file
b10mcfw.xxx	Firmware for BDI1000 for CPU ColdFire targets
cf2jed10.xxx	JEDEC file for the BDI1000 logic device (for old V2 cores)
cf3jed20.xxx	JEDEC file for the BDI1000 logic device
bdiifc32.dll	BDI Interface DLL
xxxxxx.pro	Predefined Program sets

Installing BDI Pro:

- Create a new directory on your hard disk, for example C:\BDIPRO.
- Copy the entire contents of the enclosed diskette into this directory.

2.6 Configuration

Before you can use the full functionality of the bdiPro software, you must configure the system correctly. The Setup Menu enables you to perform the following configuration tasks:

- Set the correct communication parameters between the PC and the BDI. --> **Communication**
- Load or update the firmware / logic --> **Firmware**
- Configure the target system: memory type and memory organization --> **Target Memory**
- Program the initialization routines for the target system. --> **Target Initlists**

Any time you need information about specific menus and dialog boxes, you can display the integrated Help screens by pressing the F1 function key.

The Edit and Target menus will only become active when you have specified a memory type (see Target Memory in the Setup Menu).

2.6.1 BDI1000 Setup/Update

First make sure that the BDI is properly connected (see Chapter 2.1 to 2.4). The BDI must be connected via RS232 to the Windows host.



To avoid data line conflicts, the BDI1000 must be disconnected from the target system while programming the logic for an other target CPU (see Chapter 2.1.1).

The following dialogbox is used to check or update the BDI firmware and logic and to set the network parameters.

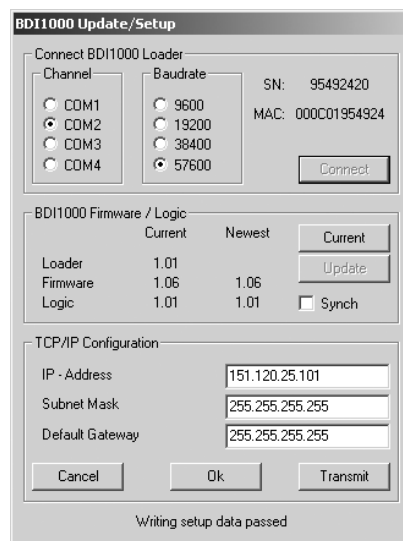

dialog box «BDI1000 Update/Setup»

The following options allow you to check or update the BDI firmware and logic and to set the network parameters:

Channel	Select the communication port where the BDI1000 is connected during this setup session.
Baudrate	Select the baudrate used to communicate with the BDI1000 loader during this setup session.
Connect	Click on this button to establish a connection with the BDI1000 loader. Once connected, the BDI1000 remains in loader mode until it is restarted or this dialog box is closed.
Current	Press this button to read back the current loaded BDI1000 software and logic versions. The current loader, firmware and logic version will be displayed.
Update	This button is only active if there is a newer firmware or logic version present in the execution directory of the BDI setup software. Press this button to write the new firmware and/or logic into the BDI1000 flash memory / programmable logic.

Synch	Because some older V2 ColdFire cores (e.g. MCF5272) need synchronous signals at the BDM interface, the BDI uses a different logic for this cores. Check this box only if your target is a MCF5204, MCF5206, MCF5206e or MCF5272. The BDI automatically selects the correct JEDEC file. Make sure that there is the correct logic loaded for the target CPU you are using.
IP Address	Enter the IP address for the BDI1000. Use the following format: xxx.xxx.xxx.xxx e.g.151.120.25.101 Ask your network administrator for assigning an IP address to this BDI1000. Every BDI1000 in your network needs a different IP address.
Subnet Mask	Enter the subnet mask of the network where the BDI is connected to. Use the following format: xxx.xxx.xxx.xxxe.g.255.255.255.0 A subnet mask of 255.255.255.255 disables the gateway feature. Ask your network administrator for the correct subnet mask.
Default Gateway	Enter the IP address of the default gateway. Ask your network administrator for the correct gateway IP address. If the gateway feature is disabled, you may enter 255.255.255.255 or any other value..
Transmit	Click on this button to store the network configuration in the BDI1000 flash memory.

In rare instances you may not be able to load the firmware in spite of a correctly connected BDI (error of the previous firmware in the flash memory). **Before carrying out the following procedure, check the possibilities in Appendix «Troubleshooting».** In case you do not have any success with the tips there, do the following:

- Switch OFF the power supply for the BDI and open the unit as described in Appendix «Maintenance»
- Place the jumper in the «**INIT MODE**» position
- Connect the power cable or target cable if the BDI is powered from target system
- Switch ON the power supply for the BDI again and wait until the LED «MODE» blinks fast
- Turn the power supply OFF again
- Return the jumper to the «**DEFAULT**» position
- Reassemble the unit as described in Appendix «Maintenance»

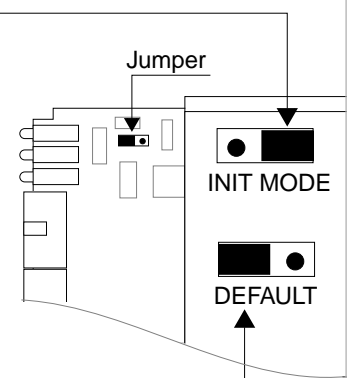

3 Specifications

Operating Voltage Limiting	2.5 ... 5.25VDC
Power Supply Current (max)	900mA@2.5V 700mA@3.3V 450mA@5.0V
RS232 Interface: Baud Rates	9'600,19'200, 38'400, 57'600,115'200
Data Bits	8
Parity Bits	none
Stop Bits	1
Network Interface	10 BASE-T
Serial Transfer Rate between BDI and Target	5.5 Mbit/s (BDM) 12 Mbit/s (JTAG)
Supported target voltage	2.7 ... 5 VDC
Operating Temperature	+ 5 °C ... +60 °C
Storage Temperature	-20 °C ... +65 °C
Relative Humidity (noncondensing)	<90 %rF
Size	160 x 85 x 35 mm
Weight (without cables)	280 g
Electromagnetic Compatibility (EMC)	EN 50081-2, EN 50082-2



Specifications subject to change without notice

4 Environmental notice



Disposal of the equipment must be carried out at a designated disposal site.

5 Declaration of Conformity (CE)

Declaration of Conformity
This declaration is valid for the following product:
Type of device: BDM/JTAG Interface
Product name: BDI1000
The signing authorities state, that the above mentioned equipment meets the requirements for emission and immunity according to
EMC Directive 89/336/EEC
The evaluation procedure of conformity was assured according to the following standards:
EN50081-2
EN50082-2
This declaration of conformity is based on the test report no. QNL-E079-05-9-a of Quinel, Zug, accredited according to EN 45001.
Manufacturer:
Abatron AG
Stöckenstrasse 4
CH-6221 Rickenbach
Authority:

Max Vock
Marketing Director

Ruedi Dummermuth
Technical Director
Rickenbach, November 2, 1999

6 Warranty

ABATRON Switzerland warrants the physical diskette, cable, BDI1000 and physical documentation to be free of defects in materials and workmanship for a period of 24 months following the date of purchase when used under normal conditions.

In the event of notification within the warranty period of defects in material or workmanship, ABATRON will replace defective diskette, cable, BDI1000 or documentation. The remedy for breach of this warranty shall be limited to replacement and shall not encompass any other damages, including but not limited loss of profit, special, incidental, consequential, or other similar claims. ABATRON Switzerland specifically disclaims all other warranties- expressed or implied, including but not limited to implied warranties of merchantability and fitness for particular purposes - with respect to defects in the diskette, cable, BDI1000 and documentation, and the program license granted herein, including without limitation the operation of the program with respect to any particular application, use, or purposes. In no event shall ABATRON be liable for any loss of profit or any other commercial damage, including but not limited to special, incidental, consequential, or other damages.

Failure in handling which leads to defects are not covered under this warranty. The warranty is void under any self-made repair operation except exchanging the fuse.

Appendices

A Troubleshooting

Problem

The firmware can not be loaded.

Possible reasons

- The BDI is not correctly connected with the target system (see chapter 2).
- The power supply of the target system is switched off or not in operating range (2.5 VDC ... 5 VDC) --> MODE LED is OFF or RED
- The built in fuse is damaged --> MODE LED is OFF
- The BDI is not correctly connected with the Host (see chapter 2).
- A wrong communication port (Com 1...Com 4) is selected.

Problem

No working with the target system (loading firmware is ok).

Possible reasons

- Wrong pin assignment (BDM/JTAG connector) of the target system (see chapter 2).
- Target system initialization is not correctly --> enter an appropriate target initialization list.
- An incorrect IP address was entered (BDI1000 configuration)
- BDM/JTAG signals from the target system are not correctly (short-circuit, break, ...).
- The target system is damaged.

Problem

Network processes do not function (loading the firmware was successful)

Possible reasons

- The BDI1000 is not connected or not correctly connected to the network (LAN cable or media converter)
- An incorrect IP address was entered (BDI1000 configuration)

B Maintenance

The BDI needs no special maintenance. Clean the housing with a mild detergent only. Solvents such as gasoline may damage it.

If the BDI is connected correctly and it is still not responding, then the built in fuse might be damaged (in cases where the device was used with wrong supply voltage or wrong polarity). To exchange the fuse or to perform special initialization, please proceed according to the following steps:



Observe precautions for handling (Electrostatic sensitive device)
Unplug the cables before opening the cover.
Use exact fuse replacement (Microfuse MSF 1.6 AF).

1

1.1 Unplug the cables

2

2.1 Remove the two plastic caps that cover the screws on target front side (e.g. with a small knife)

2.2 Remove the two screws that hold the front panel

3

3.1 While holding the casing, remove the front panel and the blue elastic sealing

4

4.1 While holding the casing, slide carefully the print in position as shown in figure below

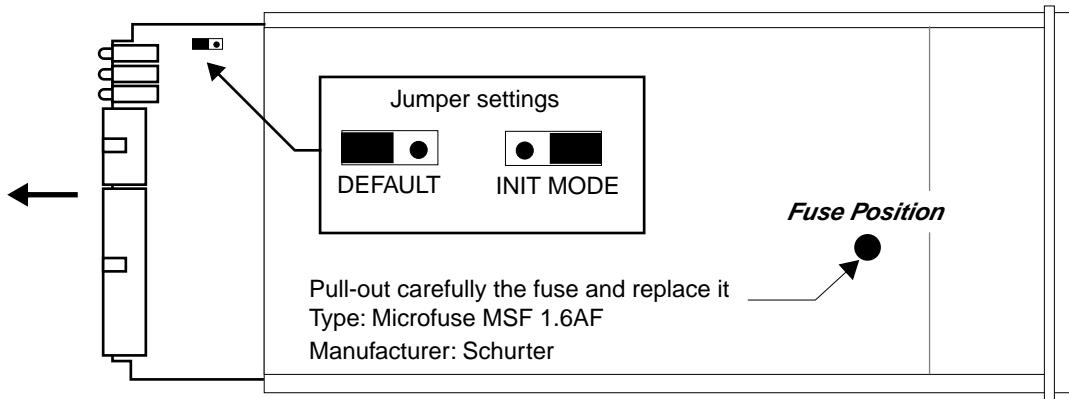

5

Reinstallation

5.1 Slide back carefully the print. Control that the LEDs align with the holes in the back panel.

5.2 Push carefully the front panel and the blue elastic sealing on the casing. Check that the LEDs align with the holes in the front panel and that the position of the sealing is as shown in the figure below.

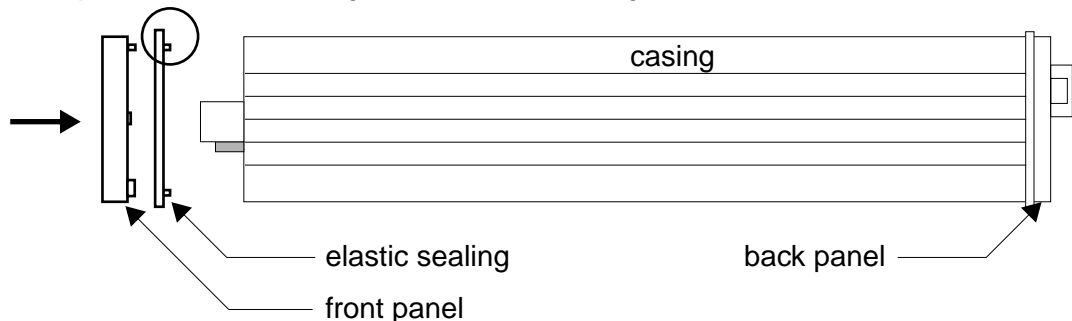

5.3 Mount the screws (do not overtighten it)

5.4 Mount the two plastic caps that cover the screws

5.5 Plug the cables



Observe precautions for handling (Electrostatic sensitive device)
Unplug the cables before opening the cover.
Use exact fuse replacement (Microfuse MSF 1.6 AF).

C Trademarks

All trademarks are property of their respective holders.