

*bdipro*®

for  
M-CORE



# User Manual

Manual Version 1.01 for BDI2000



© 1993-2001 ABATRON AG

---

<b>1 Introduction .....</b>	<b>3</b>
1.1 BDI2000.....	3
1.2 Functions .....	4
<b>2 Installation .....</b>	<b>5</b>
2.1 Connecting the BDI2000 to Target.....	5
2.1.1 Changing Target Processor Type .....	7
2.2 Connecting the BDI2000 to Power Supply.....	8
2.2.1 External Power Supply .....	8
2.2.2 Power Supply from Target System .....	9
2.3 Status LED «MODE» .....	10
2.4 Connecting the BDI2000 to Host .....	11
2.4.1 Serial line communication .....	11
2.4.2 Ethernet communication .....	12
2.5 Installation of the bdiPro Software .....	13
2.6 Configuration .....	13
2.6.1 BDI2000 Setup/Update .....	14
<b>3 Specifications .....</b>	<b>16</b>
<b>4 Environmental notice .....</b>	<b>17</b>
<b>5 Declaration of Conformity (CE).....</b>	<b>17</b>
<b>6 Warranty .....</b>	<b>18</b>
 <b>Appendices</b>	
<b>A Troubleshooting .....</b>	<b>19</b>
<b>B Maintenance .....</b>	<b>20</b>
<b>C Trademarks .....</b>	<b>22</b>

## 1 Introduction

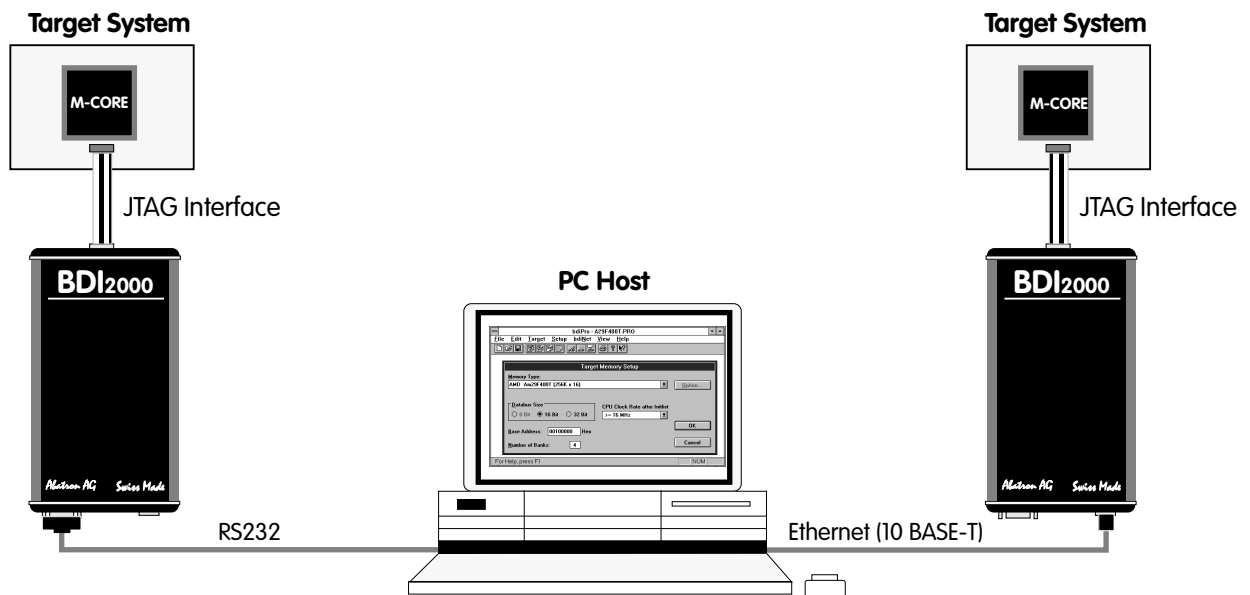

bdiPro is a powerful software package, allowing on-board programming with the BDI2000 from Abatron. bdiPro eliminates the inefficient, individual chip programming, particularly for surface-mounted designs. The unprogrammed memories can be soldered to the printed circuit board and programmed simultaneously on a just-in-time basis.

### 1.1 BDI2000

The BDI2000 is a processor system in a small box. It implements the interface between the BDM/JTAG pins of the target CPU and a 10Base-T Ethernet / RS232 connector. BDI2000 is powered by a MC68360, 512Kbyte RAM and a flash memory of 1024Kbyte. As a result of consistent implementation of lasted technology, the BDI2000 is optimally prepared for further enhancements. The firmware and the programmable logic of the BDI2000 can be updated by the user with a simple Windows based configuration program. The BDI2000 supports 1.8 – 5.0 Volts target systems (3.0 – 5.0 Volts target systems with Rev. A/B).

## 1.2 Functions

The bdiPro software provides the following functions:

<b>File</b>	<i>Load/Save</i>	• Save and recall user defined program sets
	<i>Print</i>	• Print the active program set
	<i>Print Preview</i>	• Display the active program set on the screen
	<i>Print Setup</i>	• Select the printer and the printer connection
	<i>Print Comment</i>	• Edit the headers and comment
<b>Edit</b>	<i>Load</i>	• Load Motorola S-Record and Intel hex program files
	<i>Store</i>	• Store the local memory image in S-Record format
	<i>Dump</i>	• Load the target system data into local memory
	<i>Edit</i>	• Edit the local memory image
	<i>Clear</i>	• Clear the local memory image
	<i>Fill</i>	• Fill a local memory area with pattern
	<i>Checksum</i>	• Calculation of checksum
<b>Target</b>	<i>Erase</i>	• Erase the target memory (all / sectors)
	<i>Program</i>	• Program the target memory
	<i>Verify</i>	• Compare the target system memory with local memory
<b>Setup</b>	<i>Communication</i>	• Communication setup between the PC and the BDI
	<i>Firmware</i>	• Load and verify the firmware
	<i>Target Memory</i>	• Target memory setup (memory type and memory organisation)
	<i>Target Initlists</i>	• User configurable program sequences for target system initialization (clock, chip select...)  • If required, you can write special routines that runs before or after the program/erase process (pre-programming, post-programming / pre-erase, post-erase).
<b>Help</b>		• Information about menus and dialog boxes by pressing the F1 function key

## 2 Installation

### 2.1 Connecting the BDI2000 to Target

The enclosed cable to the target system is designed for the standard JTAG/OnCE connector. In case where the target system has the same connector layout, the cable can be directly connected.



In order to ensure reliable operation of the BDI (EMC, runtimes, etc.) the target cable length must not exceed 20 cm (8").

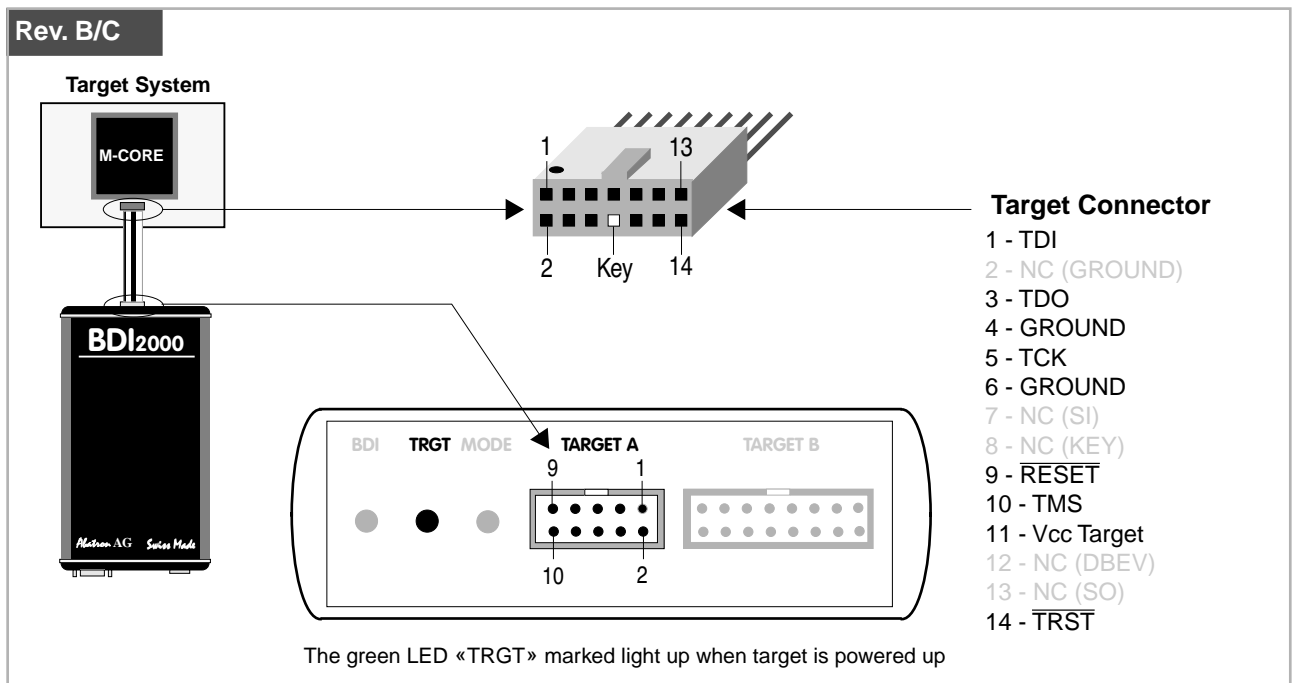
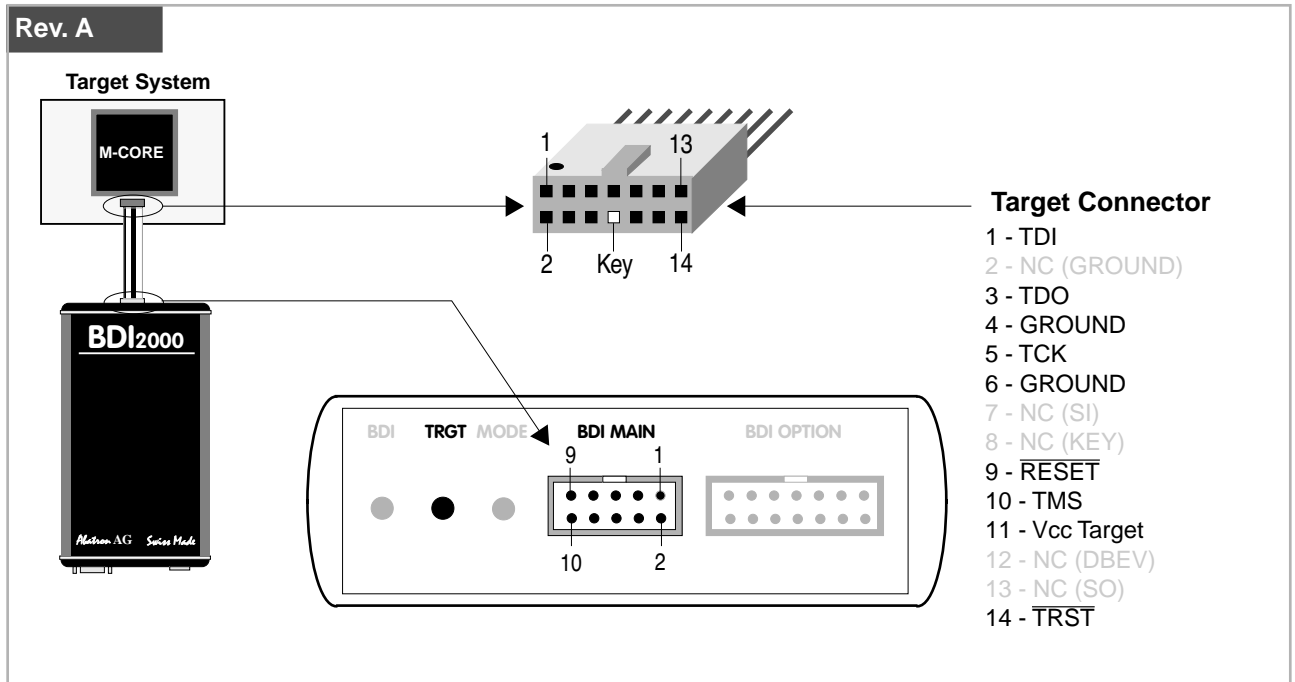

For BDI MAIN / TARGET A connector signals see table on next page.

**BDI MAIN / TARGET A Connector Signals**

Pin	Name	Description
1	(TMS1)	This pin is currently not used.
2	$\overline{\text{TRST}}$	<b>JTAG Test Reset</b> This open collector output of the BDI2000 resets the JTAG TAP controller on the target.
3+5	GND	<b>System Ground</b>
4	TCK	<b>JTAG Test Clock</b> This output of the BDI2000 connects to the target TCK line.
6	TMS0	<b>JTAG Test Mode Select</b> This output of the BDI2000 connects to the target TMS line.
7	$\overline{\text{RESET}}$	This open collector output of the BDI2000 is used to reset the target system.
8	TDI	<b>JTAG Test Data In</b> This output of the BDI2000 connects to the target TDI line.
9	Vcc Target	<b>1.8 – 5.0V:</b> This is the target reference voltage. It indicates that the target has power and it is also used to create the logic-level reference for the input comparators. It also controls the output logic levels to the target. It is normally fed from Vdd I/O on the target board.  <b>3.0 – 5.0V with Rev. A/B :</b> This input to the BDI2000 is used to detect if the target is powered up. If there is a current limiting resistor between this pin and the target Vdd, it should be 100 Ohm or less.
10	TDO	<b>JTAG Test Data Out</b> This input to the BDI2000 connects to the target TDO line.

All the pins need to be connected to the target system for the debug operation.

### 2.1.1 Changing Target Processor Type

Before you can use the BDI2000 with an other target processor type (e.g. M-CORE <--> PPC), a new setup has to be done (see Appendix A). During this process the target cable must be disconnected from the target system. The BDI2000 needs to be supplied with 5 Volts via the BDI OPTION connector (Rev. A) or via the POWER connector (Rev. B/C). For more information see chapter 2.2.1 «External Power Supply».



**To avoid data line conflicts, the BDI2000 must be disconnected from the target system while programming the logic for an other target CPU.**

## 2.2 Connecting the BDI2000 to Power Supply

### 2.2.1 External Power Supply

The BDI2000 needs to be supplied with 5 Volts (max. 1A) via the BDI OPTION connector (Rev. A) or via POWER connector (Rev. B/C). The available power supply from Abatron (option) or the enclosed power cable can be directly connected. In order to ensure reliable operation of the BDI2000, keep the power supply cable as short as possible.



For error-free operation, the power supply to the BDI2000 must be between 4.75V and 5.25V DC. **The maximal tolerable supply voltage is 5.25 VDC. Any higher voltage or a wrong polarity might destroy the electronics.**

**Rev. A**

The green LED «BDI» marked light up when 5V power is connected to the BDI2000

**BDI OPTION Connector**

- 1 - NOT USED
- 2 - GROUND
- 3 - NOT USED
- 4 - GROUND
- 5 - BREAK-ENA
- 6 - GROUND
- 7 - NOT USED
- 8 - GROUND
- 9 - BREAK-A
- 10 - GROUND
- 11 - BREAK-B
- 12 - Vcc (+5V)
- 13 - Vcc Target (+5V)
- 14 - Vcc (+5V)

**Rev. B/C**

The green LED «BDI» marked light up when 5V power is connected to the BDI2000

**POWER Connector**

- 1 - Vcc (+5V)
- 2 - VccTGT
- 3 - GROUND
- 4 - NOT USED

**Please switch on the system in the following sequence:**

- 1 --> external power supply
- 2 --> target system

### 2.2.2 Power Supply from Target System

The BDI2000 needs to be supplied with 5 Volts (max. 1A) via BDI MAIN target connector (Rev. A) or via TARGET A connector (Rev. B/C). This mode can only be used when the target system runs with 5V and the pin «Vcc Target» is able to deliver a current up to 1A@5V. For pin description and layout see chapter 2.1 «Connecting the BDI2000 to Target». Insert the enclosed Jumper as shown in figure below. **Please ensure that the jumper is inserted correctly.**



For error-free operation, the power supply to the BDI2000 must be between 4.75V and 5.25V DC. **The maximal tolerable supply voltage is 5.25 VDC. Any higher voltage or a wrong polarity might destroy the electronics.**

**Rev. A**

The green LEDs «BDI» and «TRGT» marked light up when target is powered up and the jumper is inserted correctly

**BDI OPTION Connector**

- 1 - NOT USED
- 2 - GROUND
- 3 - NOT USED
- 4 - GROUND
- 5 - BREAK-ENA
- 6 - GROUND
- 7 - NOT USED
- 8 - GROUND
- 9 - BREAK-A
- 10 - GROUND
- 11 - BREAK-B
- 12 - Vcc (+5V)
- 13 - Vcc Target (+5V)
- 14 - Vcc BDI2000 (+5V)

**Rev. B/C**

The green LEDs «BDI» and «TRGT» marked light up when target is powered up and the jumper is inserted correctly

**POWER Connector**

- 1 - Vcc BDI2000 (+5V)
- 2 - Vcc Target (+5V)
- 3 - GROUND
- 4 - NOT USED

### 2.3 Status LED «MODE»

The built in LED indicates the following BDI states:

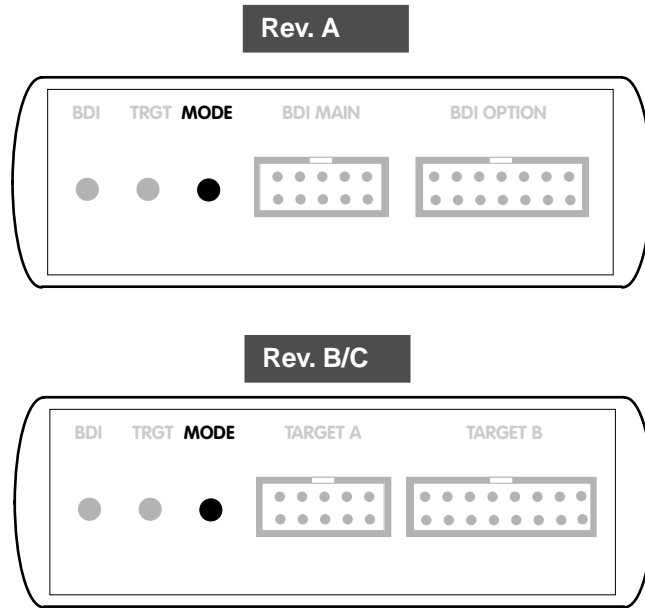

MODE LED	BDI STATES
OFF	The BDI is ready for use, the firmware is already loaded.
ON	The power supply for the BDI2000 is < 4.75VDC.
BLINK	The BDI «loader mode» is active (an invalid firmware is loaded or loading firmware is active).

## 2.4 Connecting the BDI2000 to Host

### 2.4.1 Serial line communication

The host is connected to the BDI through the serial interface (COM1...COM4). The communication cable between BDI and Host is a serial cable (RXD / TXD are crossed). There is the same connector pinout for the BDI and for the Host side (Refer to Figure below).

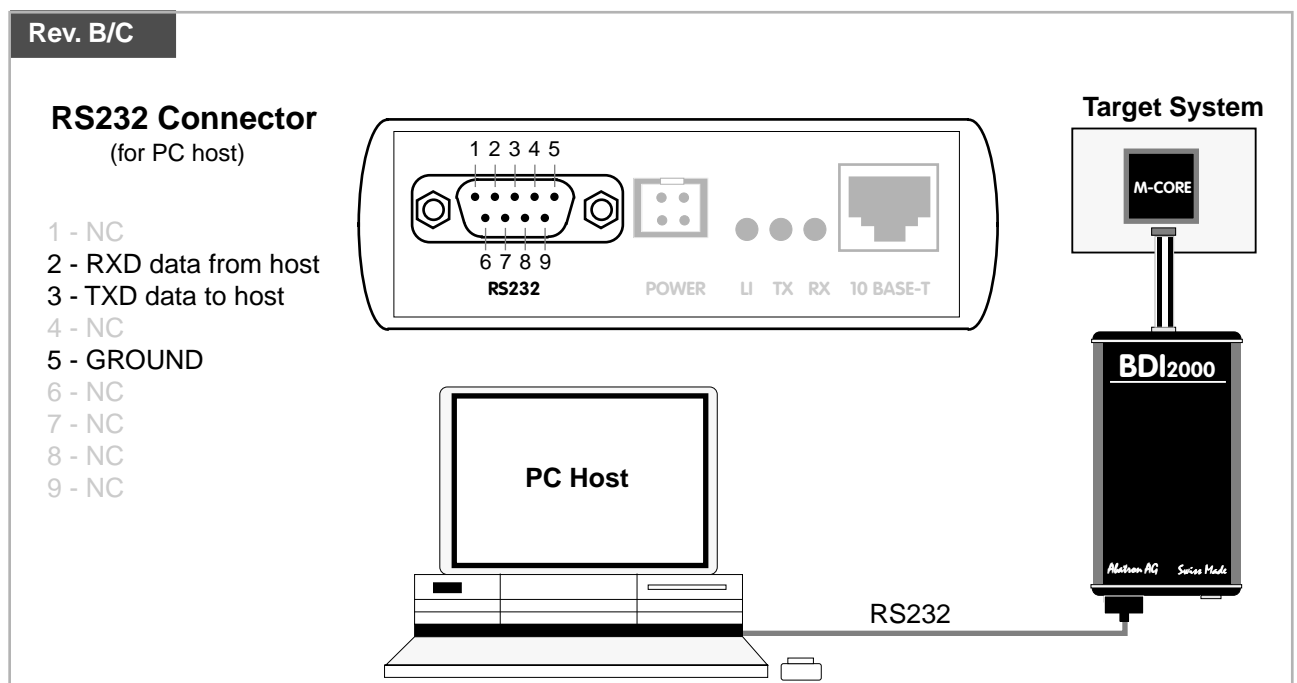
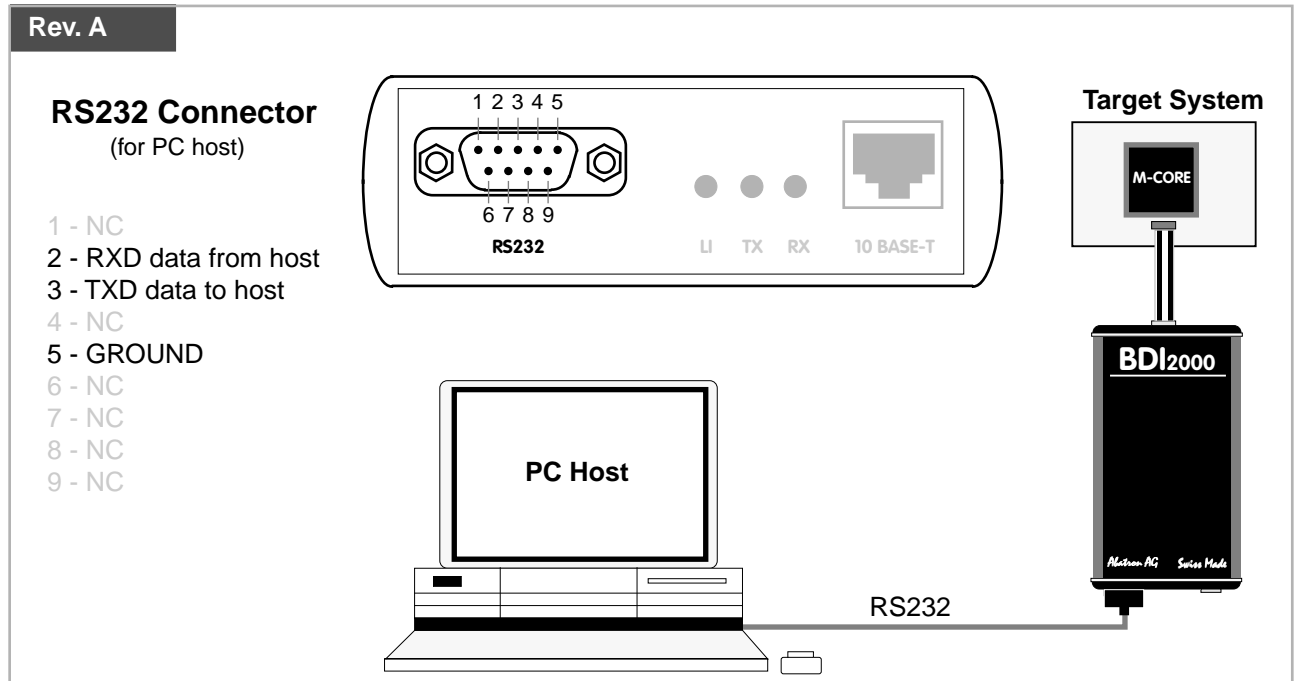

## 2.4.2 Ethernet communication

The BDI2000 has a built-in 10 BASE-T Ethernet interface (see figure below). Connect an UTP (Unshielded Twisted Pair) cable to the BDI2000. For thin Ethernet coaxial networks you can connect a commercially available media converter (BNC-->10 BASE-T) between your network and the BDI2000. Contact your network administrator if you have questions about the network.

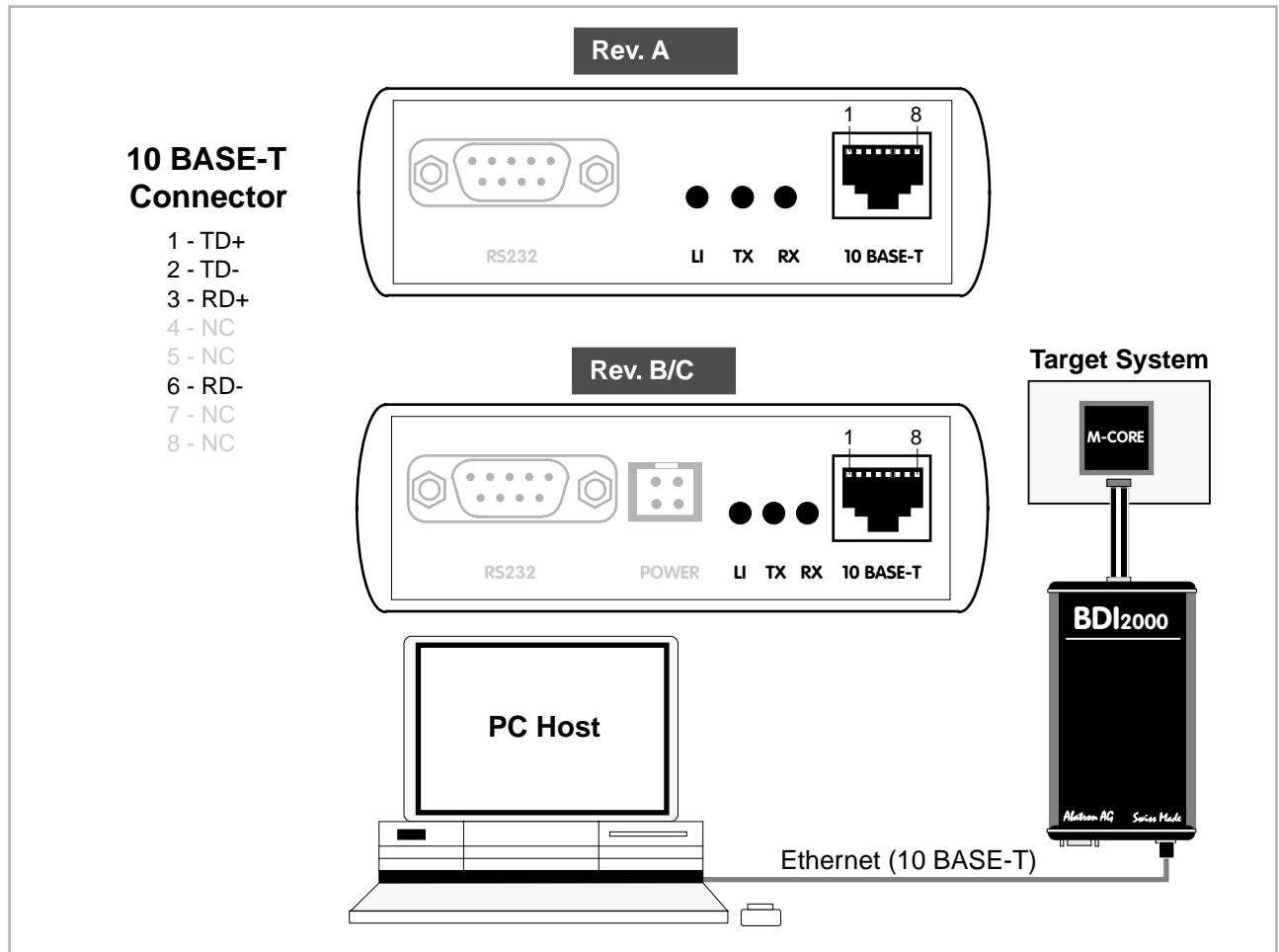

The following explains the meanings of the built-in LED lights:

LED	Name	Description
LI	Link	When this LED light is ON, data link is successful between the UTP port of the BDI2000 and the hub to which it is connected.
TX	Transmit	When this LED light BLINKS, data is being transmitted through the UTP port of the BDI2000
RX	Receive	When this LED light BLINKS, data is being received through the UTP port of the BDI2000

## 2.5 Installation of the bdiPro Software

On the enclosed diskette you will find the bdiPro software and the firmware required for the BDI. Copy all the files of the desired diskette to a directory on your hard disk.

The following files are on the diskette:

b20pgmmc.exe	bdiPro program
b20pgmmc.hlp	Helpfile for bdiPro program
b20pgmmc.cnt	Help contents file
b20mmcfw.xxx	Firmware for BDI2000 for M-CORE targets
mmcjed20.xxx	JEDEC file for the BDI2000 (Rev. A/B) logic device programming
mmcjed21.xxx	JEDEC file for the BDI2000 (Rev. C) logic device programming
bdiifc32.dll	BDI Interface DLL
xxxxxx.pro	Predefined Program sets

### Installing BDI Pro:

- Create a new directory on your hard disk, for example C:\BDIPRO.
- Copy the entire contents of the enclosed diskette into this directory.

## 2.6 Configuration

Before you can use the full functionality of the bdiPro software, you must configure the system correctly. The Setup Menu enables you to perform the following configuration tasks:

- Set the correct communication parameters between the PC and the BDI. --> **Communication**
- Load or update the firmware / logic --> **Firmware**
- Configure the target system: memory type and memory organization --> **Target Memory**
- Program the initialization routines for the target system. --> **Target Initlists**

Any time you need information about specific menus and dialog boxes, you can display the integrated Help screens by pressing the F1 function key.

The Edit and Target menus will only become active when you have specified a memory type (see Target Memory in the Setup Menu).

## 2.6.1 BDI2000 Setup/Update

First make sure that the BDI is properly connected (see Chapter 2.1 to 2.4). The BDI must be connected via RS232 to the Windows host.



**To avoid data line conflicts, the BDI2000 must be disconnected from the target system while programming the logic for an other target CPU (see Chapter 2.1.1).**

The following dialogbox is used to check or update the BDI firmware and logic and to set the network parameters.

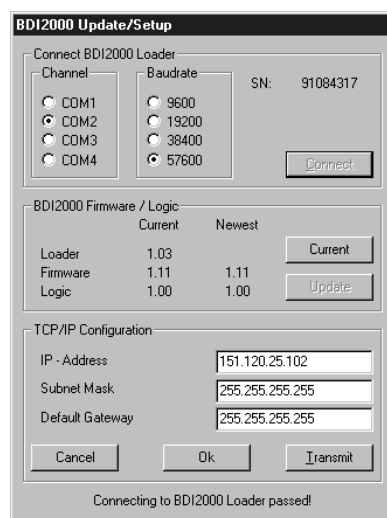

dialog box «BDI2000 Update/Setup»

The following options allow you to check or update the BDI firmware and logic and to set the network parameters:

- |          |   |
|----------|---|
| Channel  | Select the communication port where the BDI2000 is connected during this setup session.   |
| Baudrate | Select the baudrate used to communicate with the BDI2000 loader during this setup session.  |
| Connect  | Click on this button to establish a connection with the BDI2000 loader. Once connected, the BDI2000 remains in loader mode until it is restarted or this dialog box is closed.  |
| Current  | Press this button to read back the current loaded BDI2000 software and logic versions. The current loader, firmware and logic version will be displayed.  |
| Update   | This button is only active if there is a newer firmware or logic version present in the execution directory of the BDI setup software. Press this button to write the new firmware and/or logic into the BDI2000 flash memory / programmable logic. |

IP Address	Enter the IP address for the BDI2000. Use the following format: xxx.xxx.xxx.xxx.g.151.120.25.101 Ask your network administrator for assigning an IP address to this BDI2000. Every BDI2000 in your network needs a different IP address.
Subnet Mask	Enter the subnet mask of the network where the BDI is connected to. Use the following format: xxx.xxx.xxx.xxx.g.255.255.255.0 A subnet mask of 255.255.255.255 disables the gateway feature. Ask your network administrator for the correct subnet mask.
Default Gateway	Enter the IP address of the default gateway. Ask your network administrator for the correct gateway IP address. If the gateway feature is disabled, you may enter 255.255.255.255 or any other value..
Transmit	Click on this button to store the network configuration in the BDI2000 flash memory.

In rare instances you may not be able to load the firmware in spite of a correctly connected BDI (error of the previous firmware in the flash memory). **Before carrying out the following procedure, check the possibilities in Appendix «Troubleshooting».** In case you do not have any success with the tips there, do the following:

- Switch OFF the power supply for the BDI and open the unit as described in Appendix «Maintenance»
- Place the jumper in the «**INIT MODE**» position
- Connect the power cable or target cable if the BDI is powered from target system
- Switch ON the power supply for the BDI again and wait until the LED «MODE» blinks fast
- Turn the power supply OFF again
- Return the jumper to the «**DEFAULT**» position
- Reassemble the unit as described in Appendix «Maintenance»

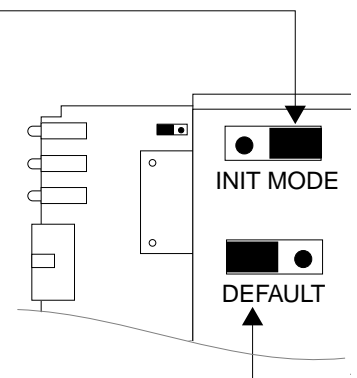

### 3 Specifications

Operating Voltage Limiting	5 VDC $\pm$ 0.25 V
Power Supply Current	typ. 500 mA max. 1000 mA
RS232 Interface: Baud Rates	9'600, 19'200, 38'400, 57'600, 115'200
Data Bits	8
Parity Bits	none
Stop Bits	1
Network Interface	10 BASE-T
Serial Transfer Rate between BDI and Target	up to 16 Mbit/s
Supported target voltage	1.8 – 5.0 V (3.0 – 5.0 V with Rev. A/B)
Operating Temperature	+ 5 °C ... +60 °C
Storage Temperature	-20 °C ... +65 °C
Relative Humidity (noncondensing)	<90 %rF
Size	190 x 110 x 35 mm
Weight (without cables)	420 g
Host Cable length (RS232)	2.5 m

Specifications subject to change without notice

## 4 Environmental notice



Disposal of the equipment must be carried out at a designated disposal site.

## 5 Declaration of Conformity (CE)

  
**DECLARATION OF CONFORMITY**

This declaration is valid for following product:

**Type of device: BDM/JTAG Interface**  
**Product name: BDI2000**

The signing authorities state, that the above mentioned equipment meets the requirements for emission and immunity according to

**EMC Directive 89/336/EEC**

The evaluation procedure of conformity was assured according to the following standards:

**EN 50081-2**  
**EN 50082-2**

This declaration of conformity is based on the test report no. QNL-E853-05-8-a of QUINEL, Zug, accredited according to EN 45001.

Manufacturer:

**ABATRON AG**  
**Stöckenstrasse 4**  
**CH-6221 Rickenbach**

Authority:

  
Max Vock  
Marketing Director

  
Ruedi Dummermuth  
Technical Director

Rickenbach, May 30, 1998

## 6 Warranty

ABATRON Switzerland warrants the physical diskette, cable, BDI2000 and physical documentation to be free of defects in materials and workmanship for a period of 24 months following the date of purchase when used under normal conditions.

In the event of notification within the warranty period of defects in material or workmanship, ABATRON will replace defective diskette, cable, BDI2000 or documentation. The remedy for breach of this warranty shall be limited to replacement and shall not encompass any other damages, including but not limited to loss of profit, special, incidental, consequential, or other similar claims.

ABATRON Switzerland specifically disclaims all other warranties- expressed or implied, including but not limited to implied warranties of merchantability and fitness for particular purposes - with respect to defects in the diskette, cable, BDI2000 and documentation, and the program license granted herein, including without limitation the operation of the program with respect to any particular application, use, or purposes. In no event shall ABATRON be liable for any loss of profit or any other commercial damage, including but not limited to special, incidental, consequential, or other damages.

Failure in handling which leads to defects are not covered under this warranty. The warranty is void under any operation except exchanging the fuse.

# Appendices

## A Troubleshooting

### Problem

The firmware can not be loaded.

### Possible reasons

- The BDI is not correct connected with the target system (see chapter 2).
- The power supply of the target system is switched off or not in operating range (4.75 VDC ... 5.25 VDC) --> MODE LED is OFF or RED
- The built in fuse is damaged --> MODE LED is OFF
- The BDI is not correct connected with the Host (see chapter 2).
- A wrong communication port (Com 1...Com 4) is selected.

### Problem

No working with the target system (loading firmware is ok).

### Possible reasons

- Wrong pin assignment (BDM/JTAG connector) of the target system (see chapter 2).
- Target system initialization is not correct --> enter an appropriate target initialization list.
- An incorrect IP address was entered (BDI2000 configuration)
- BDM/JTAG signals from the target system not correct (short-circuit, break, ...).
- The target system is damaged.

### Problem

Network processes do not function (loading the firmware was successful)

### Possible reasons

- The BDI2000 is not connected or not correctly connected to the network (LAN cable or media converter)
- An incorrect IP address was entered (BDI2000 configuration)

## B Maintenance

The BDI needs no special maintenance. Clean the housing with a mild detergent only. Solvents such as gasoline may damage it.

If the BDI is connected correctly and it is still not responding, then the built in fuse might be damaged (in cases where the device was used with wrong supply voltage or wrong polarity). For exchange the fuse or special initialization, please proceed according to the following steps:



**Observe precautions for handling (Electrostatic sensitive device)**  
**Unplug the cables before opening the cover.**  
**Use exact fuse replacement (Microfuse MSF 1.6 AF).**

1

1.1 Unplug the cables

2

2.1 Remove the two plastic caps that cover the screws on target front side (e.g. with a small knife)

2.2 Remove the two screws that hold the front panel

3

3.1 While holding the casing, remove the front panel and the red elastig sealing

**4**

4.1 While holding the casing, slide carefully the print in position as shown in figure below

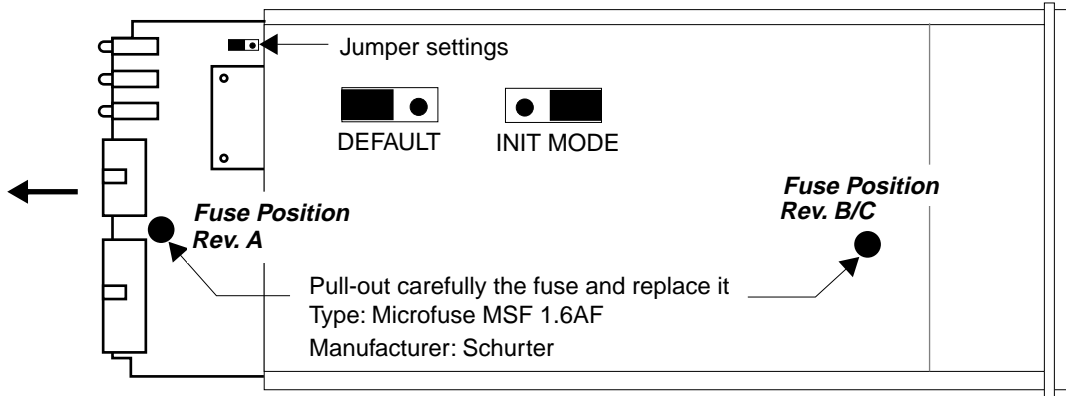

**5**

**Reinstallation**

5.1 Slide back carefully the print. Control that the LEDs align with the holes in the back panel.

5.2 Push carefully the front panel and the red elastig sealing on the casing. Control that the LEDs align with the holes in the front panel and that the position of the sealing is as shown in the figure below.

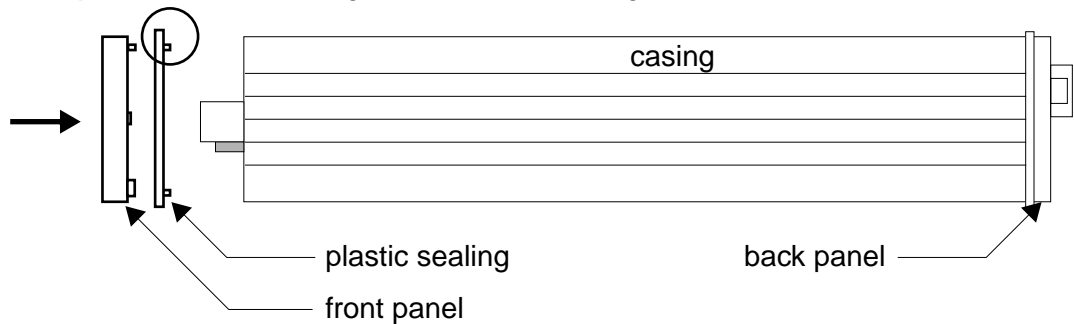

5.3 Mount the screws (do not overtighten it)

5.4 Mount the two plastic caps that cover the screws

5.5 Plug the cables



**Observe precautions for handling (Electrostatic sensitive device)  
Unplug the cables before opening the cover.  
Use exact fuse replacement (Microfuse MSF 1.6 AF).**

## **C Trademarks**

All trademarks are property of their respective holders.